



ISO 9001 : 2008 & 13485 : 2012

A Super Specialized Hi-Technology
Rehabilitation Services Center



High end Bionics
Micro Processor Controlled
Prosthetic Products

PROSTHETIC PRODUCT CATALOGUE



Also available in Android and Apple Store



www.pointinternational.in

EVO™: Advanced Foot Solution

Natural foot scan A "typical" prosthetic foot EVO foot cover EVO foot scan

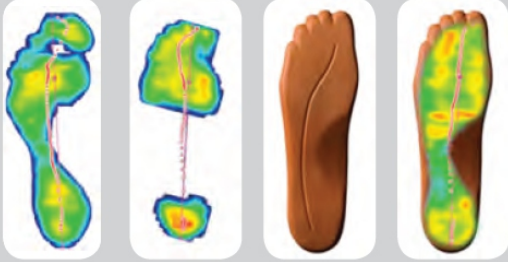

- Smoother transition from heel to toe
- Improved walking comfort and ease



MOVE NATURALLY

SAFETY • SYMMETRY • CONFIDENCE

WHAT USERS AND PROSTHETISTS ARE SAYING ABOUT THE SYMBIONIC LEG*

SAFETY

64%
of users report a
reduction in tripping

57%
of users report a
reduction in falling

*Based on responses to an Ossur survey by 17 amputees and prosthetists who used SYMBIONIC LEG for at least 3 weeks. Results may vary.

SYMMETRY

53%
of prosthetists report
reduced hip hiking.

80%
of prosthetists report
more even stride length.

27%
of
or eliminated pain.

CONFIDENCE

93%
of users report
increased confidence.

86%
users report reduced
of users report
increased activity.....

80%
of users report less
mental fatigue.

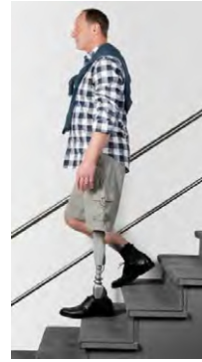
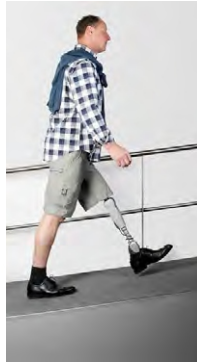

"SYMBIONIC LEG has helped restore the way that I experience everyday life. Each step I take is without even thinking about it. I have the confidence to approach whichever path I choose. I don't have to look down all the time – instead I can look around me as I walk, relaxed in the knowledge that my leg will react appropriately. This natural posture makes me feel good about myself. My disability is no longer obvious... I use both my legs, I'm as active socially as I ever was." **Hans-Jan van Dongen, The Netherlands**



SYMBIONIC LEG 3

The Latest generation of the world's first and only complete Bionic Leg





PROSTHETIC
FEET...

SACH FOOT



PI-IN05

Heel Height 10 mm, Wood keel
Size:20-30 cm

SEATTLE NATURAL DYNAMIC FOOT



PI-SNF151

- **Indications:**
Medium activity, K3, maximum weight of 111 kg (245 lbs)
- Slim, low profile foot accommodates women's shoe styles
- Life-like cosmesis developed from molds of real women's feet

SEATTLE CARBON LIGHT FOOT



PI-SCF-186

- **Indications:**
Max weight limit: 124 kg (275lb) for medium activity level.
- Product Weight 373 g for size 25 cm.
- Min clearance: 3.8 cm (1.5") from keel top to cosmesis mosis

FLEX FOOT BALANCE



FBPOxyyz

FCT0

- The Flex-Foot Balance is a comfortable multi-axial foot that combines proven durability and stability with comfort; leading to optimum patient compliance. Its full length toe lever and multi-axial design offer a smooth transition from heel strike to toe off that is absent in most competitively priced feet.

User information

- Amputation Level: Transfemoral & Transtibial
- Impact Level: Low

Indications:

- Weight of Foot: 490 gm (17.3 oz) w/ Pyramid & Foot Cover
- Adapter Options: Male Pyramid

ASPIRE FOOT



ASPLF

The Aspire Foot features an all-carbon blade design, with a dynamic heel and smooth roll-over character, sandal toe, closed foot cover and low build height make it ideal for the target markets and a convenient universal fit.

Indications :

- Amputation Level: Transfemoral, Transtibial
- Impact Level: Low to High
- Maximum Patient Weight: 100 kg (220 lbs)
- Sizes: 22-28
- Weight Of Foot: 660 gm w/ Pyramid and Foot Cover
- Build Height Standard: 80 mm w/Pyramid and Foot Cover
- Heel Height: 10 mm
- Adapter Options: Fixed Male Pyramid
- Flex Foot Characteristics: proportional response, sandal toe

FLEX FOOT ASSURE



FAPE

FCLA

The Flex-Foot Assure is ideal as a first prosthesis or a more permanent option for the less active, particularly those experiencing poor vascular health and/or diabetes.

Indications :

- Amputation Level: Transfemoral and Transtibial
- Impact Level: Low
- Maximum Patient Weight: 136 kg (300 lbs)

Foot information :

- Categories: 1-5
- Sizes: 19-30
- Weight of Foot: (Size 27) 620 gm (21.9oz) w/ Pyramid and Foot Cover
- Build Height: (Size 27) 125 mm (4.9") w/ Pyramid and Foot Cover
- Heel Height: 10 mm (3/8")
- Adapter Options: Male Pyramid or Fiberglass Tube

CHOPART

This 100% carbon keel is designed to be a flexible and durable solution for the longest amputation levels and partial foot prostheses. Includes a 10mm heel height for compatibility with standard Flex-Foot shells and low-heel shoes.

Chopart is specifically designed for people with chopart amputations as well as lisfranc, pirogoff, boyd and partial foot prostheses.



CHPOOxyy

FCA0

Indications :

- Amputation Level: Transtibial Amputees Lisfranc, Pirogoff, Boyd and Partial Foot Amputees
- Impact Level: Low to High
- Maximum Patient Weight: 147 kg (324 lbs)

Foot information :

- Categories: 1-8
- Sizes: 22-30
- Weight of Foot: (Size 27) 94 gm (3.3 oz)
- Build Height: (Size 27) 6 mm (1/4")

FLEX SYMES

Extremely low build height with a Carbon-X® Active Heel and alignment options. The Flex-Symes foot design is a carbon foot module connected to an actively deflecting carbon heel.



SLPO

FCA0

Indications :

- Amputation Level: Transtibial
- Impact Level: Low to High
- Maximum Patient Weight: 166 kg (365 lbs)

Foot information :

- Categories: Size 22-24, Cat. 1-6 / Size 27-30, Cat. 1-9
- Sizes: 22-30
- Weight of Foot: (Size 27) 602 gm (21.2 oz) w/ Foot Cover
- Build Height: (Size 27) 60 mm (2 3/8") w/ Foot Cover
- Heel Height: 10 mm (3/8")
- Adapter Options: Direct Lamination Adapter

VARI FLEX WITH EVO / LP VARI FLEX WITH EVO



VFQE/VEPExyoo

FCEA

The Vari-Flex with EVO provides an exclusive combination of comfort and dynamics.

The Vari-Flex with EVO is light-weight, easy to assemble and has a slender profile which makes it easy to cosmetically cover.

The LP Vari-Flex with EVO is designed for users with long residual limbs that do not have enough clearance for the Vari-Flex with EVO.

Indications (The Vari-Flex with EVO) :

- Amputation Level: Transfemoral & Transtibial
- Impact Level: Low to High
- Maximum Patient Weight: 166 kg (365 lbs)

Foot information :

- Categories: 1-9
- Sizes: 22-30
- Weight of Foot: (Size 27) 700 gm (24.7oz) w/ Pyramid & Foot Cover (Size 27) 170 mm (6 w/ Pyramid & Foot Cover)
- Build Height: 10 mm & 19 mm (3/8" & 3/4")
- Heel Height: 10 mm (3/8")
- Adapter Options: Fixed Male Pyramid, Quick-Align™ Male Pyramid or Carbon Tube

Indications (The LP Vari-Flex with EVO) :

- Amputation Level: Transfemoral & Transtibial
- Impact Level: Low to High
- Maximum Patient Weight: 166kg (365lbs)

Foot information :

- Categories: Size 22-24, Cat. 1-5 / Size 25-30, Cat. 1-9
- Sizes: 22-30
- Weight of Foot: (Size 27) 540 gm (19oz) w/ Pyramid & Foot Cover (Size 27) 68 mm (2 11/16") w/ Pyramid and Foot Cover
- Build Height: 10 mm (3/8")
- Heel Height: 10 mm (3/8")
- Adapter Options: Male Pyramid or Lamination Adapter

VARI FLEX XC



XCPE

FCA0

Representing the latest advances in Flex-Foot technology, Vari-Flex XC combines superb dynamics and comfort for a range of activities.

Indications :

- Amputation Level: Transfemoral & Transtibial
- Impact Level: Low to High
- Maximum Patient Weight: 166 kg (365 lbs)

Foot information :

- Categories: 1-9
- Size: 22-30
- Weight of Foot: (Size 27) 712 gm w/ Foot Cover and Sock
- Build Height: (Size 27) 155 mm (6 1/8") w/ Male Pyramid & Foot Cover
- Heel Height: 10 mm (3/8"), 19 mm (3/4") available on special order
- Adapter Options: Male Pyramid

LP ROTATE WITH EVO

The LP Rotate with EVO has been specially designed for people with long residual limbs, which have insufficient clearance for the Re-Flex Rotate with EVO.



VLXE

FCEA

Indications :

- Amputation Level: Transfemoral and Transtibial
- Impact Level: Low to High
- Maximum Patient Weight: 147 kg (324 lbs)

Foot information :

- Categories: 1-8
- Sizes: 22-30
- Weight of Foot: (Size 27) 870 gm (30.7 oz) w/ Pyramid & Foot Cover
- Build Height: (Size 27) 149 mm (5 7/8") w/ Pyramid & Foot Cover
- Heel Height: 10 mm (3/8")
- Adapter Options: Male and Female Pyramids

RE FLEX SHOCK WITH EVO

Re-Flex Shock with EVO offers the best vertical shock absorption of all mechanical feet. With dynamic energy return and all around responsiveness the foot is a great choice for active users.



SSPE

FCEA

Indications :

- Amputation Level: Transfemoral and Transtibial
- Impact Level: Low to High
- Maximum Patient Weight: 166 kg (366 lbs)

Foot information :

- Categories: 1-9
- Sizes: 22-30
- Weight of Foot: (Size 27) 1048 gm (35.4 oz) w/ Foot Cover
- Build Height Standard: (Size 27) 210-238 mm (8 1/4" - 9 3/8") w/ Foot Cover & Male Pyramid
- Build Height Tall: (Size 27) 255-288 mm (10" - 11 5/16") w/ Foot Cover & Male Pyramid
- Heel Height: 10 mm (3/8"), 19 mm (3/4") available on special order
- Adapter: Male Pyramid

KINTERA HYDRAULIC FOOT

- Low to moderate impact K3 level users who would benefit from improved stability and comfort
- Transtibial and transfemoral; Unilateral and bilateral amputees
- Users with knee or flexion limitations



PI-ROM

Indications :

- Range of Ankle Motion: 12°
- Sizes: 22-31 cm
- Build Height (average): 120 mm (4.3 in) 25 cm
- User Weight Limit: 125 kg (275 lbs)
- Product Weight (average): 795 g (25 cm, incl. foot shell)
- Stiffness Categories: 7 (low & moderate impact)
- Split Toe: Yes
- Heel Height: 10 mm (3/8 in)
- Foot Shell CAP: Upon request
- Skin Tones: 3
- Attachment Type: Male pyramid

PROPRIO FOOT

PROPRIO FOOT is an adaptive prosthetic device for low to moderately active below-knee amputees that mimics natural foot motion. Motor-powered ankle motion increases ground clearance and reduces the risk of tripping and falling. This allows users to traverse different kinds of terrain in a natural and secure way.



Indications :

- Amputation Level: Transtibial
- Impact Level: Low to Moderate
- Maximum Patient Weight: 125 kg (276 lbs)

Foot information :

- Categories: Size 22-24; Cat. 1-5 / Size 25-30; Cat. 1-8
- Size: 22-30

Weight of PROPRIO FOOT :

- (Size 27, Cat 5): 1424g (50oz) w/Foot Plate, Foot Cover and Battery
- Heel Height Adjustability: Up to 50mm (2")
- Build Height: 168mm (6 5/8") - 176mm (7")

FLEX RUN WITH NIKE SOLE

The Flex-Run with Nike Sole offers unmatched performance & efficiency for amputees and prosthetists.



Indications :

- Amputation Level: Transfemoral and Transtibial
- Impact Level: High to Extreme
- Maximum Patient Weight: 130kg (287lbs)

Foot information :

- Categories: 1-9
- Sizes: One Size Per Category
- Weight of Foot (Cat. 5): 400 gm (14.1 oz) 694 gm (24.4oz) with Sole & Male Pyramid
- Build Height: 261 mm (10 1/4") 277 mm (10 7/8") with Sole and Male Pyramid
- Adapter Options: Male or Female Bolt on Pyramid

FLEX FOOT CHEETAH XTREME

The blade of champions – inspired by the world's fastest. Cheetah Xtreme is the optimal short-distance sprinting foot, a holder of multiple world records. The Nike Spike Pad has been designed exclusively for the Cheetah. It provides specialized traction that has been optimized for the blade.



Indications:

- Amputation Level: Transfemoral and Transtibial
- Impact Level: Extreme
- Maximum Patient Weight: 147kg (325lbs)

Foot information

- Categories: 1-9
- Sizes: One Size Per Category
- Weight of Foot: 918 gm (32.4 oz)
- Max Build Height: 530 mm (20 14/16")
- Min Build Height: 375 mm (14 3/4")
- Adapter Options: Lamination Connector

FLEX FOOT CHEETAH XTEND

Kick into high gear with a responsive and comfortable ride from start to finish.

The Cheetah Xtend is the perfect companion for longer sprints and short-distance running (400-5000 m). This highly effective carbon fiber blade has a continuous curve toward the toe offering a smooth rollover.



Indications:

- Amputation Level: Transfemoral and Transtibial
- Impact Level: Extreme
- Maximum Patient Weight: 147 kg (325 lbs)

Foot information

- Categories: 1-9
- Sizes: One Size Per Category
- Weight of Foot: 750 gm (26.4 oz)
- Max Build Height: 451 mm (17 3/4")
- Min Build Height: 330 mm (13")
- Adapter Options: Lamination Connector

ASPIRE™ KIT

The Aspire product line is an economic transtibial solution, targeted for moderate to high activity level prosthetic users. Available in a complete kit consisting of a silicone locking liner, ratchet pin lock, endoskeletal adapters, and carbon foot, it is the right choice for many amputees. The Aspire series is specially designed for emerging markets in Asia, where durability and affordability are important, along with functionality and cosmesis.

LINER

Locking umbrella more secure suspension
3mm stiff Silicone: increases durability, better soft tissue stabilization
10cm matrix improves distal end stability, decreases elongation
Textile: easier donning and doffing, more cosmetic color



COMPONENT SET

Aluminum material: lightweight, strong, durable
Ratchet lock: audible lock increases feeling of safety for user
Offset tube clamp adapter, offset female pylon: easier fabrication and alignment.



FOOT

Carbon composite material: good energy storage and return, smoother rollover
Sandal toe foot cover: better cosmesis
Dust shield: protects foot, increases durability
80mm low build height: suitable for most amputation lengths
660g lightweight design: decreases energy consumption
Soft or stiff heel firmness: suitable for different user body weights and activity levels

COMFORTABLE AND DURABLE

Intimate suspension and stabilization of soft tissues Soft but durable silicone protects residual limb, and reduces shear forces and peak pressures within the socket

OPTIMAL FUNCTIONALITY

Advanced carbon fiber technology that allows high energy return reduces impact on the residual limb and helps amputees to walk more easily

EASY FABRICATION AND ADJUSTMENTS

Single-step lamination
NEW adjustable alignment components helps for easy fabrication and adjustments.



ASPIRE™

PATIENT PROFILE

Amputation Level:	Transtibial
Impact Level:	Low to High
Maximum Patient Weight:	100kg

PRODUCT INFORMATION

Build Height:	193-329mm
---------------	-----------

LINER INFORMATION ASPIRE

Size Standard:	18,20,22,23.5,25,26.5,28,30,32,34,36
Profile:	3mm
Matrix:	10cm
Measurement:	4cm Above the end of the stump

FOOT INFORMATION

Stiffness	Soft or Firm
Sizes:	22-28
Weight of Foot: (Size 27)	660g w/ Pyramid and Foot Cover
Build Height: (Size 27)	80mm w/ Pyramid and Foot Cover
Heel Height:	10mm
Adapter Options:	Fixed Male Pyramid

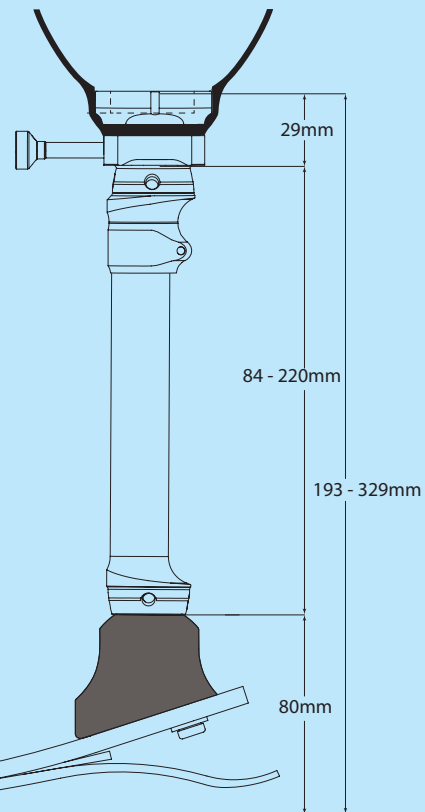

ICECAST MSS MATERIAL KIT

Aspire kit can be used with Össur Modular Socket System (MSS) technology, please contact us to get more information.

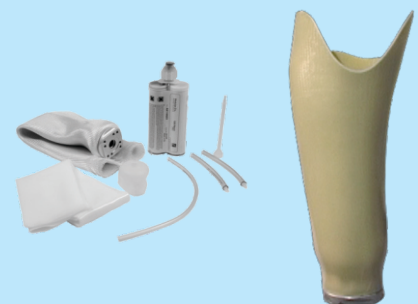

Kit ordering information

PART#	DESCRIPTION	INCLUDES
ASPLxyyz	Aspire Leg	Aspire Component Set, Aspire Foot & Foot Cover
AS-BLLxx	Aspire Liner	Aspire Liner

x: S (soft) or F (firm)
 yy: size 22-28
 z: R (right) or L (left)

Please specify when ordering brown covers, add "BR" to the end of the part number.

xx: Size 18-36

www.ossur.com



UNITY™ SLEEVELESS VACUUM SYSTEM



UNITY™ SLEEVELESS VACUUM SYSTEM

Unity®

Unity offers the security and freedom of vacuum suspension, but without the sensation and restrictions of a sleeve. This advanced system from effectively addresses volume fluctuation and is totally compatible with Flex-Foot technology.

Key advantages:

- No sleeve required: Greater mobility and user acceptance
- 15-22 in Hg Vacuum: Effective volume stabilization
- Simple design: Quick and easy to achieve/release vacuum
- Independent pump: Foot function uncompromised
- Light weight: Complete system weighs only 130 gm

Unity for all:

With the Unity Vacuum System, there is finally an elevated vacuum system for all users. Whether an above-knee or below-knee, low active or high active, mechanical or microprocessor solution is required, the Unity Vacuum System offers the flexibility to combine a variety of feet and knees to achieve the optimal combination of equipment for each unique user.

COMPATIBLE FEET FOR UNITY®



Re-Flex Rotate
with Evo (RSPE)



Re-Flex Shock
with Evo (SSPE)



LP Rotate with Evo
(VLXE)



Proprio Foot
PRP2



LP Vari-Flex
with Evo (VEPExy00)



Vari-Flex with Evo
(VFQE)



Vari-Flex XC
(XCPE)



KNEE
JOINTS....

KNEE JOINTS....

BASIC MECHANICAL KNEE JOINTS

Safety Knee Joint



Ken Dall

PI-KK-D200

- The knee is designed to use the swing axis and the brake axis as a load-dependent brake.
- The function of the axis friction is adjustable for improving control of the swing phase.

Functions :

- Friction Adjustment

Technical Data :

- Material: Stainless Steel
- Overall Length: 75 mm
- Weight: 498 gm
- Knee Flexion Angle 140°
- Mobility Level 1 ~ 2
- Max. Body Weight 100 KG

Mechanical 4 Bar Knee Joint



KAT-KM1

- 4-bar polycentric structure ensures stance phase stability
- Adjustable extension assist
- Adjustable flexion and extension resistances

Technical Data :

- Knee Type: Polycentric
- Poly. Knee Type: 4-Bar
- Activity Level: Low to Moderate (K1-K2)
- Weight Limit: 100 kg (220lbs)
- Attachment: Proximal Pyramid
- Build Height: 146 mm (5 3/4")
- Overall Height: 156 mm (6 1/8")
- Weight: 618 gm (21.8oz)
- Colour: Black
- Knee Flexion: 156°

4 Bar Mechanical Knee Joint



WIN WALKER

with Knee Disarticulation joint

PI-3M11

PI-3M11-KD

- It can change to different adaptors
- High stability and reliability
- Lightweight design
- Extension stop can be adjusted according to your needs
- It can change to different adaptors according to the needs.
- KD Socket Adaptor
- Pyramid
- No adaptors, it can connect directly with the socket

Technical Data :

- Weight 690 gm 750 gm
- Material AL AL
- Weight Limit 100 kg 100 kg

Modular Single Axis Knee with Locking

Mechanical monocentric knee joint with brake function and optional manual lock



PI-D601-40



- Material Aluminum
- Amputation Level Above-knee
- Overall fitted height (1) approx. 115 mm
- Effective fitted height (2) approx. 63 mm
- Fitted height (3) approx. 23 mm
- Weight approx. 495 g
- Prox. connection Pyramid
- Dist. connection Integrated 30 mm tube receiver
- Swing phase Integrated extension spring
- Stance phase Adjustable axle geometry
- Axes Monocentric
- Flexion angle approx. 145° without socket

Four Bar Linkage Knee Joint With Manual Lock



PI-3M10L

The special features is 4 bar linkage stabilize free Knee joint, also use a lock. This Knee joint is appropriate for 15 years of young boy (Active patient) up-to 45 years (As a free Stabilize Knee Joint), after 50-80 can use as a autolock, unlock suitable for all above knee amputee patient male/ female.

Technical Data :

- Weight 640 gm
- Material AL
- Weight Limit 100 kg

Balance Knee



BKN12500

The Balance Knee is designed to offer the less active user a high level of security and stability.

Technical Data :

- Amputation Level: Transfemoral
- Impact Level: Low
- Max. Patient Weight: 125 kg (275lbs)
- Weight Of Knee: 590 gm (20.8oz)
- Build Height: 154 mm (6 1/6")
- Knee Flexion: 180° (165° with Locking feature)

PNEUMATIC KNEE JOINTS

Tehlin HY-STAN 4 Bar Pneumatic Knee



TK-4P00S

This state-of-the-art prosthetic knee module provides lightweight, unequaled function and durability for the active, to extremely active, above knee amputee. All bearing axis ensure unsurpassed smoothness of action. The device and its full adjustability provides variable cadence with an optimum gait while providing the highest degree of cosmesis.

Technical Data :

- Material Carbon fiber
- System height 260 mm
- System weight 920 gm
- Maximum flexion angle 130°
- Maximum 100 kg body weight

4 Bar Pneumatic Knee Joint



Ken Dall

PI-KK-503

- New double-chamber pneumatic unit improves the swing phase to ensure a natural gait by independent flexion and extension adjustment which be amended based on patient's weight and personal habit.
- CNC manufactured increases the structure strength.
- Fashion external.

Technical Data :

- Material Aluminum
- Overall Length 205 mm
- Weight 713 gm
- Knee Flexion 145° Angle
- Mobility Level 2 ~ 3
- Max. Body Weight 100 kg

4 Bar Pneumatic Knee Joint



RAY-RP1

The RP1 pneumatic knee is the first RayoMe first series product. We hope the RP1 users have light of life and a confidence participate daily in usual daily activities and can create a joyful life. With orange and black color design represents the power and the personality of prosthesis. The adjustable design of the pneumatic cylinder can be fine-tuned the knee flexion and extension velocity independently more natural stable gait.

Technical Data :

- Material Aluminum alloy, Titanium alloy
- System height 233 mm
- System weight 980 gm
- Maximum flexion angle 159°
- Maximum 125 kg body weight

Total Knee 1900 (Elastic Polymer Swing Control)

The industry standard in polycentric knees, the Total Knee, has been redesigned and given a whole new look. Now the knee is stronger and more durable. The knee accommodates everyday walking requirements. **Through use of friction within an elastic polymer medium, the swing phase is controlled and steady.** That combined with the extension promoter which assists in limiting heel rise and moving the knee into a fully extended position, ensures every amputee has access to the superior attributes of a Total Knee.



1900

Technical Data :

- Amputation Level: Transfemoral, Knee Disarticulation
- Impact Level: Low
- Maximum Patient Weight: 100 kg (220 lbs)
- Weight of Knee: 675 gm (23.8 oz)
- Build Height: 173 mm (6 13/16")
- Knee Flexion: Stop at 160°



A-114040



A-122300



A-834300 S
A-835300 T



A-845300

HYDRAULIC KNEE JOINTS

Six Bar Hydraulic Knee Joint W/L Pyramid

Tehlin Hydraulic, Polycentril Knee



- High efficiency hydraulic cylinder system
- Special 4-bar mechanical design with adjustable initial ICR
- The resistances of flexion and extension are adjusted Independently
- Carbon Tube

Technical Data :

- | | |
|------------------------------|--------------------------------------|
| • Material: | Aluminum alloy, Titanium alloy |
| • System height: | 273 mm |
| • System weight: | 1060 gm |
| • Maximum flexion angle: | 138° |
| • Maximum body weight: | 125 kg |
| • Modular connector options: | Apple Green , Wine Red , Pearl White |

Six Bar Hydraulic Knee Joint W/L Thread AD



The NK-6 has a unique 6-Bar polycentric structure, which provides stability in the stance phase. An original mechanical sensing mechanism, the p-MRS system automatically detects the walking status and then controls the stability accordingly. The stance flexion feature and the smooth swing phase by a hydraulic cylinder provide a comfortable gait to the user.

Technical Data :

- | | |
|---|--|
| • Proximal Connection | Screw Head |
| • Selective Lock | Yes |
| • Total Length | 197 mm |
| • A ref. measurement | 14.5 mm |
| • B ref. measurement | 156 mm |
| • Weight | 980 gm |
| • Max. Knee Flexion Angle | 170° |
| • Material | Titanium & Aluminum |
| • Max. Body Weight Prosthesis & High Active User) | 125 kg (100 kg for Hip |
| • Mobility Grade | Low ~ Mid Active (K-Level 2+3, Mobility Class 2+3) |



The NK-6 has a unique 6-Bar polycentric structure, which provides stability in the stance phase. An original mechanical sensing mechanism, the p-MRS system automatically detects the walking status and then controls the stability accordingly. The stance flexion feature and the smooth swing phase by a hydraulic cylinder provide a comfortable gait to the user.

Technical Data :

- | | |
|---|--|
| • Proximal Connection | Male Pyramid Adapter |
| • Selective Lock | Yes |
| • Total Length | 197 mm |
| • A ref. measurement | 14 mm |
| • B ref. measurement | 156 mm |
| • Weight | 940 gm |
| • Max. Knee Flexion Angle | 170° |
| • Material | Titanium & Aluminum |
| • Max. Body Weight Prosthesis & High Active User) | 125 kg (100 kg For Hip |
| • Mobility Grade | Low ~ Mid Active (K-Level 2+3, Mobility Class 2+3) |

Total Knee 2000



The Total Knee, has been redesigned and given a whole new look. Now the knee is stronger and more durable. This is the go-to knee for superior shock absorption, increased comfort and a more natural gait. Mid-swing shortening offers increased toe clearance during swing to prevent hip-hiking and the 3-phase hydraulic swing control seven bar linkage accommodates changes in walking speed. Plus, the adjustable stance flexion feature mimics the knee flexion that occurs during early stance, reducing shock and stress on the residual limb.

Technical Data :

- | | |
|---------------------------|--------------------|
| • Amputation Level: | Transfemoral, Knee |
| • Disarticulation | |
| • Impact Level: | Moderate to High |
| • Maximum Patient Weight: | 100 kg (220 lbs) |
| • Weight Of Knee: | 690 gm (24.3 oz) |
| • Build Height: | 173 mm (6 13/16") |
| • Knee Flexion: | Stop at 160° |

MAUCH KNEE



MKN01360

- Single axis hydraulic knee system with swing and stance control (SNS®). Designed for multi-speed ambulation
- Ultra-durable Aluminum frame
- Weight limit of 136 kg (300 lbs)
- Roller bearings at knee axis & cylinder attachment points for smooth action
- Yielding stance control
- Mode selector switch allows manual locking and free swing functions.
- Low Swing Resistance kits & High Stance Resistance kits are also available

Technical Data :

- Amputation Level: Transfemoral
- Impact Level: Moderate to Extreme
- Maximum Patient Weight: 136 kg (300 lbs)
- Weight Of Knee With Cylinder: 1.14 kg (40 oz)
- Build Height: 248 mm (9 3/4")
- Knee Flexion: Stop at 115°

MAUCH KNEE PLUS



MKN01660

The Mauch Knee Plus is a heavy duty version of the Mauch Knee. Built on the same advanced technology, it was developed in order to accommodate the needs of users requiring a higher weight limit. A slightly different and more robust frame means that the Mauch Knee Plus offers all of the benefits of the standard Mauch Knee to patients up to 166 kg (365 lbs).

Technical Data :

- Amputation Level: Transfemoral
- Impact Level: Moderate to Extreme
- Maximum Patient Weight: 166 kg (365 lbs)
- Weight Of Knee With Cylinder: 1.21 kg (42.68 oz)
- Build Height: 210.5 mm (8 5/16")
- Knee Flexion: Stop at 125°

TOTAL KNEE 2100



2100

The Total Knee 2100 is a highly refined knee with 3-phase hydraulic swing control designed to withstand the rigors of more active amputees. With a weight limit of 125kg (275lbs) and 25% increased fluid capacity over Model 2000, the Total Knee 2100 offers the ultimate in stability, control, efficiency and durability.

Technical Data :

- Amputation Level: Transfemoral, Knee Disarticulation
- Impact Level: Moderate to Extreme
- Maximum Patient Weight: 125 kg (275 lbs)
- Weight Of Knee: 900 gm (1.98 lbs)
- Build Height: 175mm (6.9")
- Knee Flexion: Stop at 160°



ELECTRONIC KNEE JOINT



PI-N1-C111T

Users can walk naturally without feeling awkward. The Intelligent Knee was the world's first computerized knee. At each step, the microprocessor monitors the user's walking speed, and automatically controls the swing speed of the knee joint.

Technical Data :

- Max. flexion: 160°
- Weight limit: 100 kg
- Battery life: 2 years (approx.)

HYBRID KNEE



Nabtesco

PI-N1-C311

A highly accurate yielding function is embodied in our new Intelligent Knee. To the controlled power of the hydraulic system we have added soft pneumatic control. This fusion of microprocessor controlled technologies gives you a hybrid system that prevents unnerving buckling at the knee, and enables easier walking in greater comfort.

Technical Data :

- Max. flexion 140°
- Weight limit 125 kg
- Battery life 2 years (approx.)

POLYCENTRIC KNEE JOINT WITH 3-VALVE HYDRAULIC



PI-N1-OH5

- Above-knee amputation or knee disarticulation
- Mobility classes 3,4
- Max. body weight 220 lb

Technical Data :

- Material Aluminum
- Max. flexion 150°
- Weight limit 965 kg
- Total fitted height(1) approx. 199 mm
- Effective fitted height (2) approx. 147 mm
- Fitted height (3) approx. 32 mm

OP4 PNEUMATIC MONOCENTRIC KNEE JOINT



PI-N1-OH4

- Above-knee amputation
- Mobility class: moderate 3
- Maximum body weight 220 lbs

Technical Data :

- Material Aluminum
- Max. flexion 145°
- Weight limit 680 kg
- Total fitted height(1) approx. 198 mm
- Effective fitted height (2) approx. 146 mm
- Fitted height (3) approx. 26 mm

PLIÉ 2.0 MPC KNEE

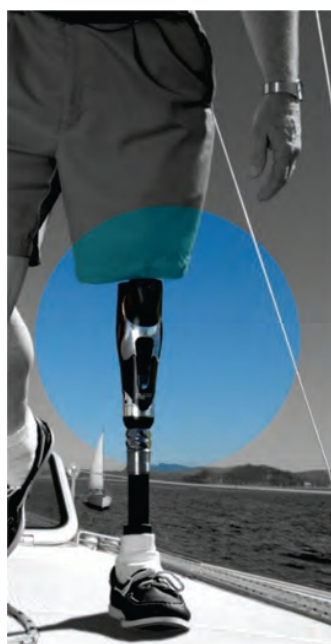

Plié2.0's electronic components are sealed for water resistance. However, the product is not intended for frequent submersion in water and should not be used as a swimming or shower prosthesis. Repeated submersion will result in corrosion of metal parts which will degrade knee performance. If the knee comes into contact with salt or chlorinated water, it should be rinsed with fresh water and dried immediately. If the knee requires general cleaning, wipe the outside surfaces with a cloth and rubbing alcohol. For further information about how to care for your Plié 2.0MPCKnee, contact your prosthetist.



RHEO KNEE[®] 3 (RKN120007)

A PERFECT BALANCE OF STABILITY AND DYNAMICS.



Bionic Protector for
RHEO KNEE: BIC00110
(Optional)

RECOMMENDED CODING

Use existing L-codes for reimbursement:

- RHEO KNEE 3: Use existing L-codes for reimbursement: L5856, L5828, L5845, L5848, L5850, L5925, L5930*
- Bionic ProtectorL: 5705

INDICATIONS

- Transfemoral and knee/hip disarticulation amputees
- Low to moderate impact levels
- Maximum patient weight is 300 lbs (136kg)

TECHNICAL SPECIFICATIONS

- Minimum build height: 9 ¼" (236mm)
- Device weight: 3.59lbs (1.63kg)
- Battery life: up to 72 hours, depending on level of activity

RHEO KNEE 3 KIT OPTIONS

- RHEO KNEE 3: RKN130007
- RHEOLOGIC Workbench Software: RKNLPCWB1
- Bionic Protector for RHEO KNEE 3: BIC00110
- 24-month extended warranty: RKN2YRADDWARRANTY

RHEO KNEE 3 WARRANTY/SERVICE

36-month limited warranty, no mandatory service check
Optional 24-month extended warranty available for purchase, includes 40-month service check



RHEO KNEE[®] 3





CHILD PROSTHETICS....

CHILD'S PLAY FOOT



SLF132

- Pediatric model of the Seattle LightFoot
 - Dynamic response keel and smooth rollover
 - Shock absorption
 - Appropriate for all lower limb pediatric amputees, including Symes
- Indications:** Pediatric amputees, maximum weight of 65 kg • 144 lb
Child's Play Foot, Caucasian 13-21 cm 65 kg • 144 lb
Product Sizes -13-21 cm



SSKA610-DIS



SSL260-P

FLEX-FOOT JUNIOR



Flex-Foot Junior is a low profile and energy storing foot module with integrated male pyramid. The shape of the male pyramid contributes to progressive stiffening of the foot and the layering of the carbon fibre is specifically designed to offer the support and flexibility needed for the active lifestyle of children.

USER INFORMATION

Maximum Patient Weight	45kg
------------------------	------

FOOT INFORMATION

Categories	1-3
Sizes	16-21cm
Weight of the the foot (Size 21) with male pyramid	180g
Features	

FLEX-RUN™ WITH NIKE SOLE

The Flex-Run with Nike Sole offers unmatched performance and efficiency for amputees and prosthetists.



Össur and Nike have partnered to design the ideal running foot from the ground up, leveraging Össur's unmatched expertise in running prosthetics with Nike's world renowned traction and sole technologies. Flex-Run with Nike Sole is appropriate for Transfemoral and Transtibial users participating in high impact activities such as recreational jogging, trail running, distance running and triathlons.

USER INFORMATION

Maximum Patient Weight	130kg
Impact Level	High to Extreme

FOOT INFORMATION

Categories	1-9
Weight of the foot (Size 21) with sole and male pyramid	694g

CHILD KNEE JOINTS

Total Knee® Junior



INTRODUCTION

- Paediatric polycentric knee with geometric locking system
- Weight limit 45kg
- Adjustable stance flexion feature
- Adjustable extension promoter
- 160° of knee flexion available
- Weight of unit 380g



PI-KK-100



PI-KK-102

- Various adaptors for choice
- Light weight with various function adjustments
- Colorful Appearance
- Easy to fit and maintain
- For 22mm diameter tube

Technical Data :

Material:	Aluminum + Stainless Steel	Aluminum + Stainless Steel
Length:	110 mm	110 mm
Weight:	322 gm	348 gm
Knee Flexion Angle:	150°	140°
Mobility Level	1 ~ 2	1 ~ 2
Max. Body Weight	55 kg	55 kg

HIP JOINTS....



HIP JOINTS....

HY-STAN HIP JOINT



7E8 4

Designed for patients with hip disarticulation
Knee flexion angle apprx. 120°
Abduction, adduction and flexion/extension are continuously adjustable.

Technical Data :

- Material Stainless Steel
- System weight 830g
- Maximum body weight 100 kg

The Hy-Stan structured TH-01 provides similar functions to those of TGH-01 except for the material. It is specially designed for the hip-disarticulation or hemipelvectomy amputee requiring high security and perfect function in a cost effective consideration. Perfection in adjustable mechanism allows for up to 20° of hip flexion which provides ample hip movement for normal ambulation. The pre-bent lamination plate and angled knee connector help reduce overall fabrication and fitting time.



TH-01

Technical Data :

- Material Aluminum alloy
- System height 220 mm
- System weight 760 gm
- Maximum flexion angle 115°
- Maximum body weight 100 kg
- Modular connector options TLP-AAH, TLP-SAH

4 BAR HIP JOINT

Ken Dall



PI-KK-700

The KK-700 is a polycentric knee joint with mechanical extension and flexion assist.

Indications:

- Suitable for hip disarticulation or hemi-pelvis amputees.
- Body weight below 90 kg for regular function level amputees.
- Suitable for normal walking pattern amputees.

Technical Instruction:

- Very stable for amputees during walking gait.
- Light weight.
- Easy to fit and maintain.

GRAPH-LITE HIP JOINT



TGH-01

The TGH-01 which is a combination of advanced engineering and the latest material technique offers the unique feature of a spring loaded mechanism build into the component. The main frame is constructed of graphite composite fibers with alloy struts to minimize weight without compromising strength. The pre-bent lamination plate and angled knee connector help reduce overall fabrication and fitting time.

Indications:

- Material Carbon fiber
- System height 250 mm
- System weight 600 gm
- Maximum flexion angle 115°
- Maximum body weight 100 kg
- Modular connector options TLP-AAH, TLP-SAH



**SILICONE
LINERS.....**

ICEROSS SEAL-IN® X5 TRANSFEMORAL LINER

Its airtight fit is thanks to the flexible silicone suction suspension system, and its minimized pistoning and enhanced rotational control allows patients to enjoy greater comfort and stability.

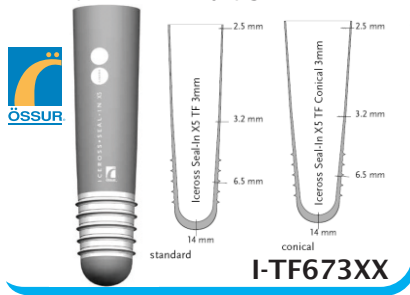

User information :

- Amputation Level: Transfemoral
- Impact Level: All

Liner information :

- Size Standard: 25,26.5,28,30,32,34,36,38,40,45,50,55.
- Size Conical: 25,26.5,28,30,32,34,36,38.
- Profile: 3 mm
- Matrix: Full Length

ICEROSS SEAL-IN® X TF

Thinner, tougher, longer, with a moveable seal for personalized fit. A new Seal-in liner has been designed specifically to address the challenges faced by a large number of people with transfemoral amputations. For many, various pressure points and the shape of their residual limb causes problems with a suction suspension liner.



Iceross Seal-In® X TF features the latest advances in Seal-in technology, with a separate and moveable seal to suit individual TF needs.

Specifications:

- Amputation Level: Transfemoral
- Impact Level: All
- Size Standard: 25,26.5,28,30,32,34,36,38,40,45,50,55.
- Size Conical: 23.5,25,26.5,28,30,32,34,36,38,40.
- Iceross Characteristics: fabric cover, active skin care, silken inner surface, conical
- Suspension Method: seal-in
- Size Seal Rings: 26,28,30,32,35,38,41,44,47,51,55,60,65,70

ICEROSS® TRANSFEMORAL LOCKING



Iceross Transfemoral is the first suspension liner exclusively designed to provide maximum stability and control for transfemoral amputees. With new textile that has improved the adhesion by 25%, the fabric cover is extremely durable and allows radial stretch and comfortable elasticity.

Specifications:

- Amputation Level: Transfemoral
- Impact Level: All
- Size Standard: 25,26.5,28,30,32,34,36,38,40,45,50,55.
- Size Conical: 25,26.5,28,30,32,34,36,38.
- Profile: 2 mm Std and 3 mm Con
- Matrix: Full Length

ICEROSS SEAL-IN® X5 TRANSTIBIAL LINER

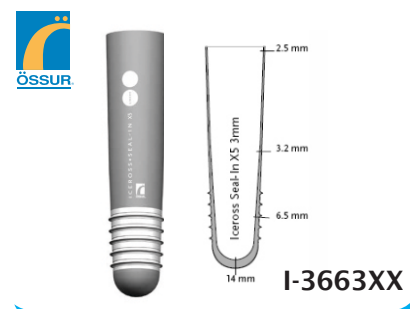

The Iceross Seal-In X5 incorporates a series of five integrated seals that conform to the shape of the residual limb and the internal socket wall, providing an airtight seal.

Specifications:

- Amputation Level: Transtibial
- Impact Level: All
- Size Standard: 18,20,22,23.5,25,26.5,28,30,32,34,36.
- Profile: 3 mm
- Matrix: 10-13 cm

TRANSFERMORAL LINER PI-AKDT / PI-AKFR

AKDT Liner : Designed with the user in mind, the ALPS Extreme Prosthetic Liner is the perfect fit for transfemoral and active transtibial amputees.

The Extreme offers 80% less vertical stretch than our other gel liners, which allows users to experience more control and stability during increased activity. The AKDT is formulated with ALPS GripGel, which contains properties that help facilitate the donning process as well as reduce pistoning and bunching behind the knee.

Features :

- Limited vertical stretch reduces movement of redundant tissue
- High circumferential stretch to assist with form fitting
- Wider distal end for ease of donning
- Offered as both a locking and cushion liner
- Distal ends are proportionate to the size of the liner
- Extended warranty with the purchase of two liners
- Available in two different thicknesses: 3mm uniform, 6 mm uniform



AKFR Liner : The Extreme Cushion Prosthetic Liner was specifically designed to meet the needs of transfemoral and active transtibial amputees. With 80% less vertical stretch than our other gel liners, the AKFR is made to withstand the demands of high activity users. Manufactured with ALPS GripGel, the Extreme Cushion Liner contains properties that have been specially formulated to assist patients with donning and suspension.

Features :

- Limited vertical stretch reduces movement of redundant tissue
- One year warranty with the purchase of one and two year warranty with two
- Available as a cushion or locking liner
- Offered in 3mm and 6mm uniform thicknesses

EASY LINER PI-ELDT / PI-ELFR

ELDT Liner : The Easyliner Prosthetic Liner was specifically designed to help promote optimum skin health in patients. Its unique formulation of ALPS EasyGel contains a special blend of antioxidants that are meant to prevent and repair damage caused by free radicals. This feature makes the Easyliner an ideal choice for diabetics or patients with adherent scar tissue or grafted skin.

Features :

- Reinforced seams for improved durability
- High performance fabric
- Easy for patients to don and doff
- Superior elongation
- Offered as both a locking and cushion liner
- Available in three thicknesses



ELFR Liner: The Easyliner Cushion Liner is especially useful for patients with sensitive skin tissue and skin irritation issues. Its soft gel texture is formulated with ALPS EasyGel to offer users a gentle and soothing alternative to traditional gel liners. The ELFR contains a rich blend of antioxidants that help promote healthy skin by effectively preventing and repairing damage caused by free radicals and hydroxyl groups. This unique quality enables the ELFR to be a superior choice for vascular patients, severe diabetics, and users with grafted skin or adherent scar tissue.

Features :

- Can be purchased as either a cushion or locking liner
- Maximum durability with reinforced seams
- Outstanding elongation
- High performance fabric for increased versatility
- Facilitated donning process for patients
- Available in three thicknesses

ASPIRE LINER

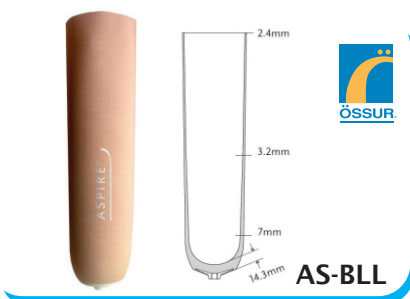

3mm Stabilo Silicone : Firm but gentle silicone provides increased durability and better soft tissue stabilization; reduces shear forces and peak pressures inside the socket

10cm Stabilizing Matrix : Minimizes longitudinal stretch and pistoning

Distal Umbrella : Properly distributes suspension forces

Textile Fabric Surface : Easier to don and doff; more cosmetic color

Sizes:

18, 20, 22, 23.5, 25, 26.5, 28, 30, 32, 34, 36

ICEROSS COMFORT® LOCKING LINER

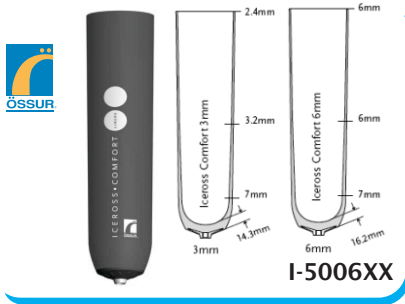

Iceross Comfort is an exceptional liner for residual limbs with bony prominences prone to pressure peaks.

Specifications:

- Amputation Level: Transtibial
- Impact Level: Low to Moderate
- Size Standard: 16,18,20,22,23.5,25,26.5,28,30,32,34,36,40,45.
- Profile: 3 mm or 6 mm
- Matrix: 10 cm or Custom 2-14 cm

ICEROS® ORIGINAL LOCKING LINER WITH COVER

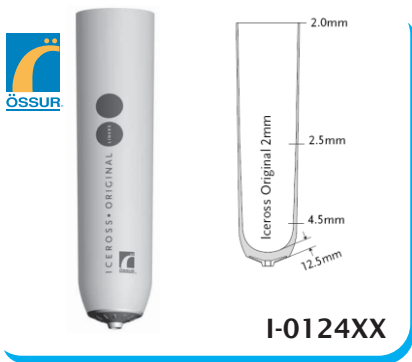

The Iceross Original is easy to don and doff and is recommended for users from low to high activity levels who require good stability and suspension. The Stabilizing Matrix effectively minimizes pistoning.

Specifications:

- Amputation Level: Transtibial
- Impact Level: Low to High
- Size Standard: 16,18, 20, 22, 23.5, 25, 26.5, 28, 30, 32, 34, 36, 38, 40, 42, 45
- Profile: 2 mm
- Matrix: 10 cm or Custom 2-14 cm

ICEROSS DERMO® CUSHION LINER WITH WAVE



This liner provides superb softness, gentle skin contact and unique Active Skin Care ingredients. The combination of DermoGel® silicone with an ultra-strong and elastic Supplex® fabric cover offers excellent durability and an intimate fit.

Specifications:

- Amputation Level: Transtibial
- Impact Level: Low to High
- Size Standard: 16, 18, 20, 22, 23.5, 25, 26.5, 28, 30, 32,34, 36, 40
- Profile: 3 mm

ICEROSS DERMO® CUSHION LINER

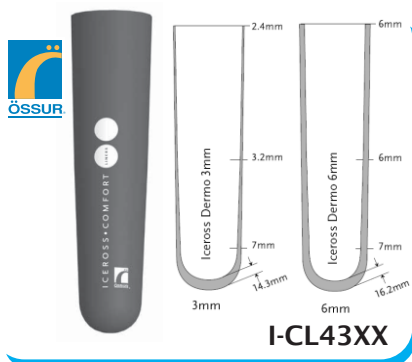

This liner provides superb softness, gentle skin contact and unique Active Skin Care ingredients. The combination of DermoGel® silicone with an ultra-strong and elastic Supplex® fabric cover offers excellent durability and an intimate fit.

Specifications:

- Amputation Level: Transtibial
- Impact Level: Low to High
- Size Standard: 16, 18, 20, 22, 23.5, 25, 26.5, 28, 30, 32, 34, 36, 40
- Profile: 3 mm or 6 mm

Iceross Comfort® Cushion Liner

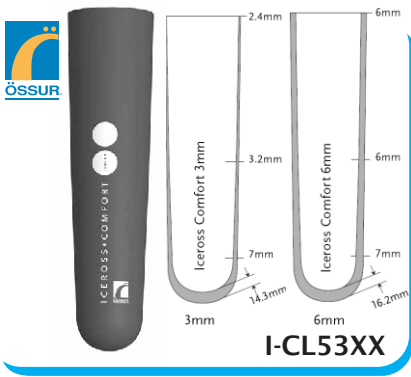

Iceross Comfort is designed with silicone and a nylon fabric cover. Iceross Comfort is an exceptional liner for residual limbs with bony prominences prone to pressure peaks, and/or conical residual limbs.

Specifications:

- Amputation Level: Transtibial
- Impact Level: Low to Moderate
- Size Standard: 16, 18, 20, 22, 23.5, 25, 26.5, 28, 30, 32, 34, 36, 40
- Profile: 3 mm or 6 mm

SUSPENSION SLEEVE

Iceross® Sleeve

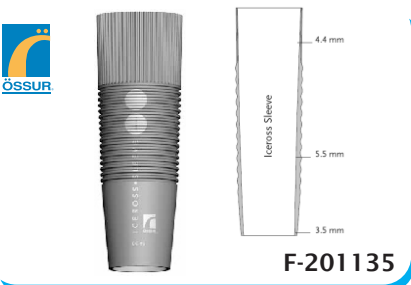

The Iceross Sleeve generates good suction, more security and less resistance at the knee.

The profile of the sleeve is thicker around the socket brims, focusing on strength at selected areas to reduce wear and tear.

Specifications:

- Amputation Level: Transtibial
- Impact Level: All
- Size: 35, 41, 49, 55, 62

Iceross® Endurance Sleeve



The Iceflex Endurance suction suspension sleeve is designed to fit over any definitive prosthetic socket. When used with a distal locking device, it provides additional security to users. In some cases the Iceflex Endurance can serve as a locking device in itself when used over a liner and definitive socket with a suction valve, ensuring that no air enters the definitive socket from above.

Specifications:

- Measure circumference 15 cm (6") above mid-patella
- Size: 35 to 62
- Length: 36 mm

EasySleeve Fabric Reinforced - SFS



EasySleeve Fabric Reinforced has superior comfort provided by GripGel. The elasticity of the fabric still allows the user excellent freedom of knee flexion. The SFS also achieves secure suspension by sealing with the skin without restricting circulation, while the GripGel sticks to the patient's skin without causing shear forces. The grip will help prevent the sleeve from rolling down the patient's limb because of the nature of the GripGel.

Specifications:

- High performance fabric
- Durable
- Longer lengths to accommodate more users
- Available in 6 mm and 3 mm uniform thickness

Below Knee Foam Cover



Above Knee Foam Cover



Below Knee Suspension Belt



PI-BK-SB

Above Knee Suspension Belt







PI-AK-SB / Size: SM to XXL (Right or Left)

SHUTTLE LOCK, SUCTION VALVE & TF SUSPENSION BELT





<p>Aspire Shuttle Lock</p>  <p>L676000/621200</p>	<p>Shuttle Lock (Bull dog)</p>   <p>PI-3 GEN A</p>	<p>ICELOCK® 100 series</p>  <p>PI-L-125000</p>		
<p>Shuttle Lock (Lamin.)</p>   <p>PI-SL 600A</p>	<p>Shuttle Lock (Draping)</p>   <p>PI-DSSL PP</p>	<p>Green Dot super seal valve</p>   <p>PI-23901000</p>		
<p>Icelock Expulsion Valve 552 series</p>   <p>L-552000</p>	<p>ICELOCK® 500 series</p>   <p>L-551002</p>	<p>Rotation adapter</p>   <p>PI-D-TKR-01</p>		
<p>Turn Table</p>   <p>PI-KPA-07</p>	<p>Turn Table</p>   <p>PI-TA1/TA2</p>	<p>Turn Table</p>   <p>PI-N-R100</p>		
<p>Water proof Prosthetic Leg Cover</p>  <p>Model-PL-11,13,15,17,19/Size:XS to XL</p>	<p>Water proof Prosthetic Full Arm Cover</p>  <p>Model-FA-12,14,16,18 Size:XS to XL</p>	<p>Easy Proth Don-Sleeve for Prosthesis</p>   <p>Size: XS to XL</p>	<p>Cosmetic Socks Below / Above Knee</p>   <p>PI-BK-CS/PS-AK-CS</p>	<p>Cosmetic Socks Below / Above Knee</p>   <p>PI-KS-41/PI-KS-42</p>

BELOW KNEE MODULAR COMPONENTS





Below Knee Kit (Entry Level)

<p>Sach Foot adapter</p>  <p>PI-241-10</p>	<p>Short Tube with 4 screw adapter</p>  <p>PI-P231-16</p>	<p>Tube Clamp adapter</p>  <p>PI-P246-20</p>	<p>Pyramid Adapter with 4 screw</p>  <p>PI-P251-14</p>
---	--	--	---





Below Knee Kit (Economy)

<p>Sach Foot adapter</p>  <p>PI-241-10A</p>	<p>Short Tube with 4 screw adapter</p>  <p>PI-P231-16A</p>	<p>Tube Clamp adapter</p>  <p>PI-P246-20A</p>	<p>Pyramid Adapter with 4 screw</p>  <p>PI-P251-14A</p>
--	---	---	--

Below Knee Kit (European)





<p>Sach Foot adapter</p>  <p>PI-270-11</p>	<p>Short Tube with 4 screw adapter</p>  <p>PI-P271-12</p>	<p>Tube Clamp adapter</p>  <p>PI-P272-13</p>	<p>Pyramid Adapter with 4 screw</p>  <p>PI-P271-14</p>
---	--	--	---

Below Knee Kit (European)



<p>Sach Foot adapter</p>  <p>PI-M441-10S PI-M441-10T</p>	<p>Short Tube with 4 screw adapter</p>  <p>PI-M431-16S PI-M431-16T</p>	<p>Tube Clamp adapter</p>  <p>PI-M446-20S PI-M446-20T</p>	<p>Pyramid Adapter with 4 screw</p>  <p>PI-M451-14S PI-M451-14T</p>
---	---	---	--

ABOVE KNEE MODULAR COMPONENTS





Above Knee Kit (Entry Level)

<p>Sach Foot adapter</p>  <p>PI-241-10</p>	<p>Short Tube with 4 screw adapter</p>  <p>PI-P247-17</p>	<p>Tube Clamp adapter</p>  <p>PI-P246-20</p>	<p>Pyramid Adapter with 4 screw</p>  <p>PI-P245-11</p>
---	--	--	---

Above Knee Kit (Economy)

<p>Sach Foot adapter</p>  <p>PI-241-10A</p>	<p>Short Tube with 4 screw adapter</p>  <p>PI-P345-11</p>	<p>Tube Clamp adapter</p>  <p>PI-P246-20A</p>	<p>Pyramid Adapter with 4 screw</p>  <p>PI-P345-12</p>
--	--	---	---

Above Knee Kit (European)

<p>Sach Foot adapter</p>  <p>PI-270-11</p>	<p>Short Tube with 4 screw adapter</p>  <p>PI-P271-15</p>	<p>Tube Clamp adapter</p>  <p>PI-P272-13</p>	<p>Pyramid Adapter with 4 screw</p>  <p>PI-P271-16</p>
---	--	--	---

Above Knee Kit (European)

<p>Sach Foot adapter</p>  <p>PI-M441-10S</p>	<p>Short Tube with 4 screw adapter</p>  <p>PI-M431-15S</p>	<p>Tube Clamp adapter</p>  <p>PI-M446-20S</p>	<p>Pyramid Adapter with 4 screw</p>  <p>PI-M451-14S</p>
---	---	---	--

ABOVE KNEE JOINTS

Single Axis Knee Joint



PI-CHG—02S

Single Axis Knee Joint with Lock/wihout lock



PI-CHG—03S-L
PI-CHG—03S

Four Bar Linkage Knee Joint



PI-CHG—05S

Four Bar Linkage Knee Joint with tube clamp



PI-CHG—09S

Single Axis Knee Joint with self lock



PI-CHG—01S

Four Bar Knee Joint for Knee Disarticulation



PI-CHG—06S

Four Bar Knee Joint for Knee Disarticulation



PI-CHG—06S

4 Bar Mechanical Knee Joint with Lock



PI-3M10L

Four Bar Linkage Joint For Hip Disarticulation



PI-CHG—12S



**P&O International Inc., Vimhans Hospital, 1 Institutional Area, Nehru Nagar,
Near PGDAV College, New Delhi-110065**

Tel : +91-11-29830490, 29842483, 8800393472, Fax : 29830489,

**E-mail : info@pointinternational.in, order@pointinternational.in,
customercare@pointinternational.in, www.pointinternational.in**

Locate us

**DELHI | MUMBAI | KOLKATA | PATNA | BANGLORE | HYDERABAD | PUNE | CHENNAI
LUDHIANA | NAGPUR | CHANDIGARH | BHANGALPUR | SHIMLA | DEHRADUN | LUCKNOW**